

Monitor Acquisition Devices Connections

Contents

1	INTRODUCTION	1
2	SENSORS CONNECTIONS	1
2.1	CURRENT LOOPS	1
2.2	IEPE INPUTS	1
2.3	UNIPOLAR VOLTAGE INPUTS	2
2.4	DIFFERENTIAL VOLTAGE INPUTS	3
3	DC POWER	3
4	AC POWER	4
5	DIGITAL I/O	4
6	LOCAL AREA NETWORK (LAN)	4
6.1	POWER OVER ETHERNET (MONITOR-4 ONLY)	4

List of Figures

FIGURE 1:	I1, I2, AND I3 TYPES OF CONNECTIONS	1
FIGURE 2:	IB TYPE OF CONNECTIONS	1
FIGURE 3:	U1, U2, AND U3 TYPES OF CONNECTIONS	2
FIGURE 4:	UD1, UD2, AND UD3 TYPES OF CONNECTIONS	3
FIGURE 5:	DC POWER PORT	3
FIGURE 6:	AC POWER PORT	4
FIGURE 7:	DI1/DO2 TYPE OF CONNECTIONS	4
FIGURE 8:	ETHERNET LAN	4
FIGURE 9:	POE - ALTERNATIVE A	5

1 Introduction

Monitor 4 and Monitor 8 acquisition devices are available with miscellaneous connections in order to accommodate different sensors signals. Here is a summary of those connections.

2 Sensors Connections

2.1 Current Loops

M12 connectors 5-contacts A-coded female socket on devices.

I1		1	IN1	4-20mA current input
		2	NC	/
		3	NC	/
		4	+20VDC	Sensor supply + output
		5	0VDC	Sensor supply - output
I2		1	IN1	4-20mA current input
		2	IN2	4-20mA current input
		3	NC	/
		4	+20VDC	Sensor supply + output
		5	0VDC	Sensor supply - output
I3		1	IN1	4-20mA current input
		2	IN2	4-20mA current input
		3	IN3	4-20mA current input
		4	+20VDC	Sensor supply + output
		5	0VDC	Sensor supply - output

Figure 1: I1, I2, and I3 types of connections

2.2 IEPE Inputs

BNC female socket on devices

IB		1	Signal	Sensor input
		2	GND	Ground

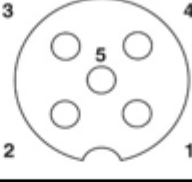
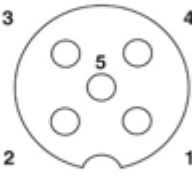
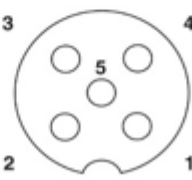
Figure 2: IB Type of connections

2.3 Unipolar Voltage Inputs

M12 connectors 5-contact A-coded female socket on devices.

U1		1	IN1	Voltage unipolar input
		2	NC	/
		3	NC	/
		4	+20VDC	Sensor supply + output
		5	0VDC	Sensor supply - output
U2		1	IN1	Voltage unipolar input
		2	IN2	Voltage unipolar input
		3	NC	/
		4	+20VDC	Sensor supply + output
		5	0VDC	Sensor supply - output
U3		1	IN1	Voltage unipolar input
		2	IN2	Voltage unipolar input
		3	IN3	Voltage unipolar input
		4	+20VDC	Sensor supply + output
		5	0VDC	Sensor supply - output

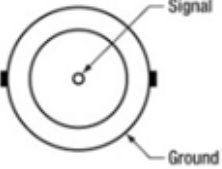
Figure 3: U1, U2, and U3 types of connections

2.4 Differential Voltage Inputs

M12 connectors 8-contact A-coded female socket on devices.

UD1		1	+20VDC	Sensor supply + output
		2	NC	/
		3	NC	/
		4	NC	/
		5	NC	/
		6	IN1-	- Voltage differential input
		7	IN1+	+ Voltage differential input
		8	0VDC	Sensor supply - output
		UD2		1
2	NC			/
3	NC			/
4	IN2-			- Voltage differential input
5	IN2+			+ Voltage differential input
6	IN1-			- Voltage differential input
7	IN1+			+ Voltage differential input
8	0VDC			Sensor supply - output
UD3				1
		2	IN3-	- Voltage differential input
		3	IN3+	+ Voltage differential input
		4	IN2-	- Voltage differential input
		5	IN2+	+ Voltage differential input
		6	IN1-	- Voltage differential input
		7	IN1+	+ Voltage differential input
		8	0VDC	Sensor supply - output

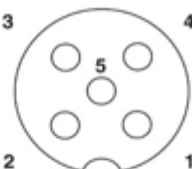
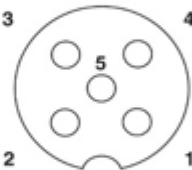
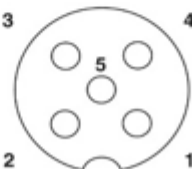
Figure 4: UD1, UD2, and UD3 types of connections

3 DC Power

M12 connector 4-contact T-Power male socket on devices

PSU		1	Earth	Earth
		2	+24VDC	Power Supply +
		3	NC	/
		4	GND	Power Supply -

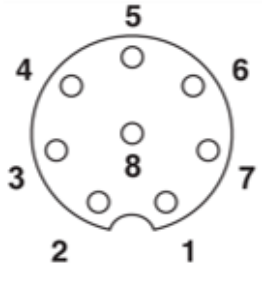
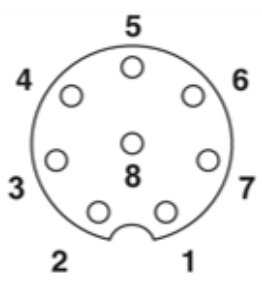
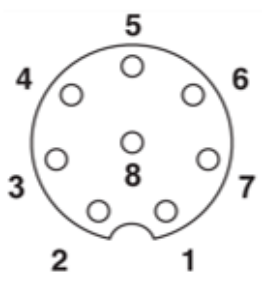
Figure 5:DC Power Port

4 AC Power

M12 connector 3-contact S-Power male socket on devices

PSU MAINS		1	L	Line
		2	N	Neutral
		⊕	PE	Protective Earth

Figure 6: AC Power Port

5 Digital I/O

M12 connectors 8-contact A-coded female socket on devices.

DI1/DO2		1	DI1+	Digital input +
		2	DI1-	Digital input -
		3	NC	/
		4	NC	/
		5	DO1+	Digital output +
		6	DO1-	Digital output -
		7	DO2+	Digital output +
		8	DO2-	Digital output -

Figure 7: DI1/DO2 Type of Connections

6 Local Area Network (LAN)

M12 connector 4-contact D-coded female socket on devices

LAN		1	TD+	Transmit+
		2	RD+	Receive+
		3	TD-	Transmit-
		4	RD-	Receive-

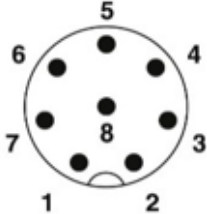
Figure 8: Ethernet LAN

6.1 Power Over Ethernet (MONITOR-4 only)

The MONITOR-4 is compliant with the *IEEE802.3af* standard. It is compatible with Power Sourcing Equipment (PSE) that use PoE Alternative A, power on data pair (Refer to IEEE802.3af for more information).

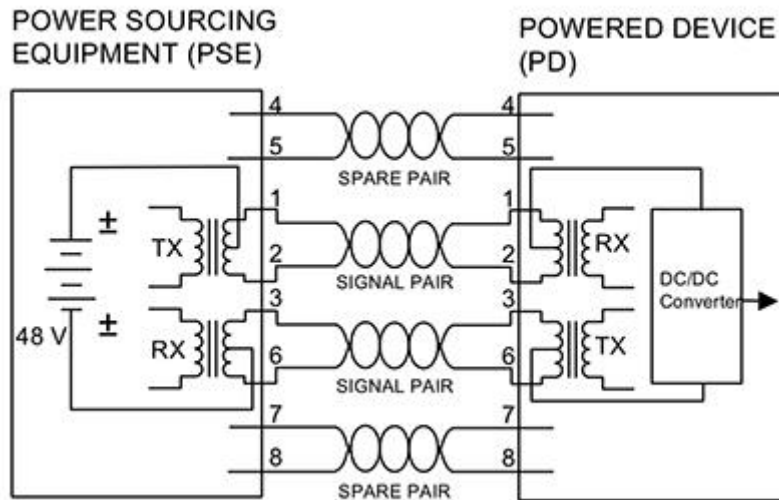



Figure 9: PoE - Alternative A

When the MONITOR-4 is connected to the Cat5e cable, it will automatically present a Powered Device (PD) signature to the PSE or Midspan Equipment, when requested. The equipment will then recognize that a powered device is connected to that line and supply power. The MONITOR-4 (i.e. Powered Device) is set to Class 0 (0.44 Watts to 12.95 Watts) operation.

	<p>Connecting both PoE and PSU supplies at the same time may create electromagnetic disturbances. Please connect one power source at a time.</p>
---	--

IMPORTANT NOTICE FOR MICROMEGA DYNAMICS DESIGN INFORMATION AND RESOURCES

MMD RESOURCES ARE PROVIDED "AS IS" AND WITH ALL FAULTS. MMD DISCLAIMS ALL OTHER WARRANTIES OR REPRESENTATIONS, EXPRESS OR IMPLIED, REGARDING MMD RESOURCES OR USE THEREOF, INCLUDING BUT NOT LIMITED TO ACCURACY OR COMPLETENESS, TITLE, ANY EPIDEMIC FAILURE WARRANTY AND ANY IMPLIED WARRANTIES OF MERCHANTABILITY, FITNESS FOR A PARTICULAR PURPOSE, AND NON-INFRINGEMENT OF ANY THIRD PARTY INTELLECTUAL PROPERTY RIGHTS.

MMD SHALL NOT BE LIABLE FOR AND SHALL NOT DEFEND OR INDEMNIFY YOU AGAINST ANY CLAIM, INCLUDING BUT NOT LIMITED TO ANY INFRINGEMENT CLAIM THAT RELATES TO OR IS BASED ON ANY COMBINATION OF PRODUCTS EVEN IF DESCRIBED IN MMD RESOURCES OR OTHERWISE. IN NO EVENT SHALL MMD BE LIABLE FOR ANY ACTUAL, DIRECT, SPECIAL, COLLATERAL, INDIRECT, PUNITIVE, INCIDENTAL, CONSEQUENTIAL OR EXEMPLARY DAMAGES IN CONNECTION WITH OR ARISING OUT OF MMD RESOURCES OR USE THEREOF, AND REGARDLESS OF WHETHER MMD HAS BEEN ADVISED OF THE POSSIBILITY OF SUCH DAMAGES.

Mailing Address: Micromega Dynamics, 10 rue du Trou du Sart, 5380 Fernelmont, Belgium
Copyright © 2020, Micromega Dynamics SA