



AVA LED

TN-OF-8

Stadium Series

Data Sheet



OUTDOOR BILLBOARD SERIES

TN-OF-8 PRO Stadium | TN-OF-8 PLUS Stadium

QUALITY IN DETAIL



- 02-03 ○ Series and Features
- 04-05 ○ Product Details
- 06 - 07 ○ Product Size - Photo
- 08-09 ○ Cabinet Detail - Safety
- 10-11 ○ Installation Guides
- 12-13 ○ Accessories - Company Info

- Advanced Contrast Brightness Black technology,
- Advanced High Refresh Rate,
- Fast installation of panel to Light Frame,
- Just Signal person to install/uninstall, saving labor cost
- Die-Casting Aluminum-Magnesium frame design, fanless design.
- No noise, lower power consumption, good heat dissipation.

TN-OF-8 PRO "Stadium"

- High Refresh Rate: 3840Hz
- B Class Led Chip
- High Quality PCB
- SOFT MASK
- Rotation 90 Degree

TN-OF-8 PLUS "Stadium"

- High Refresh Rate: 3840Hz
- A Class Led Chip
- Best Quality PCB
- SOFT MASK
- High end Refresh Rate
- 18 Bit
- Clear View
- Free Rotation
- HDR
- 4K Refresh Rate



Features

- *** Back SERVICE
- *** Light Weight
- *** Magnesium Die-Casting
- *** 4 in 1 Case weight with products: 147kg.
- *** Faster Cooling
- *** Advanced and safety Lock
- *** Nova Star Controller
- *** BLACK SHELL

MODEL NAME Version	TN-OF 8 PRO For Stadium	TN-OF 8 PLUS For Stadium
Pixel Pitch	8mm	8mm
Pixel Configuration	SMD3535	SMD3535
LED	Black Shell	Black Shell
Processing	16 Bit	18 Bit
Processing	-	-
Pixel Density / m2	15625	15625
Resolution/SQM	125 x 125	125 x 125
Cabinet Resolution 960 x 960	120 x 120	120 x 120
Pixel Density / Cabinet	14400	14400
Module Size (mm)	320x160	320x160
Cabinet Size (mm)	1012 x 960 x 145	1012 x 960 x 145
Module Per Cabinet	18 MODULE	18 MODULE
Module Resolution	40 x 20	40 x 20
Weight Per Panel Net kg. 960x950mm	25	25
Rotation per 90 Degree	○	✓
Free Rotation (with R5)	○	✓
Mapping	○	✓
Clear View	○	✓
Low Latency	○	✓
HDR	○	✓
Power Consumption (<w/sqm)	780	780
Average Power Consumption (<w/sqm)	312	312
Driving Method	1/5	1/5
Brightness	>6300 Nits	>6500 Nits
Refresh Rate	-	-
Refresh Rate High Refresh	>3840Hz	>3840Hz
Refresh Quality	High Quality	Best Quality
High Refresh (PLL inside)	✓	✓
High Refresh Power Saving	✓	✓
High Refresh Dynamic Power Saving	✓	✓
Driving IC Type	PWM	PWM
Refrate Quality 2	High Refresh	4K Refresh Rate
No Waterless Ripple of Camera	>%75	>%90
Cabinet Material	Die-Casting Magnesium	Die-Casting Magnesium
Horizontal Viewing Angle	140 (±30)	140 (±30)
Vertical Viewing Angle	140 (±30)	140 (±30)
Expected LED Lifetime %50	100,000 Hours	100,000 Hours
IP Rating	Back IP54 / Front IP65	Back IP54 / Front IP65
PCB Quality	Best Quality	Best Quality
Module - Mask Quality	Soft Mask	Soft Mask
LED Chip	Class B	Class A
Picture / Video Quality	Best Quality	Best Quality
Grey Scale	65536	262144
Control Systems	Nova Star	Nova Star
Operating Temperature Range	-20 - +60 (±10)	-20 - +60 (±10)
Operating Humidity Range	-40℃~+60℃,10%-90%RH	-40℃~+60℃,10%-90%RH
Voltage Range	200 ~240VAC	200 ~240VAC
Packing include	Plate-Power-Cat5 Cable	Plate-Power-Cat5 Cable
Certificate	CE/EMC/LVD-ATR-EUR1 ISO-9001:2015 ISO-14001:2015	CE/EMC/LVD-ATR-EUR1 ISO-9001:2015 ISO-14001:2015

CABINET SIZE

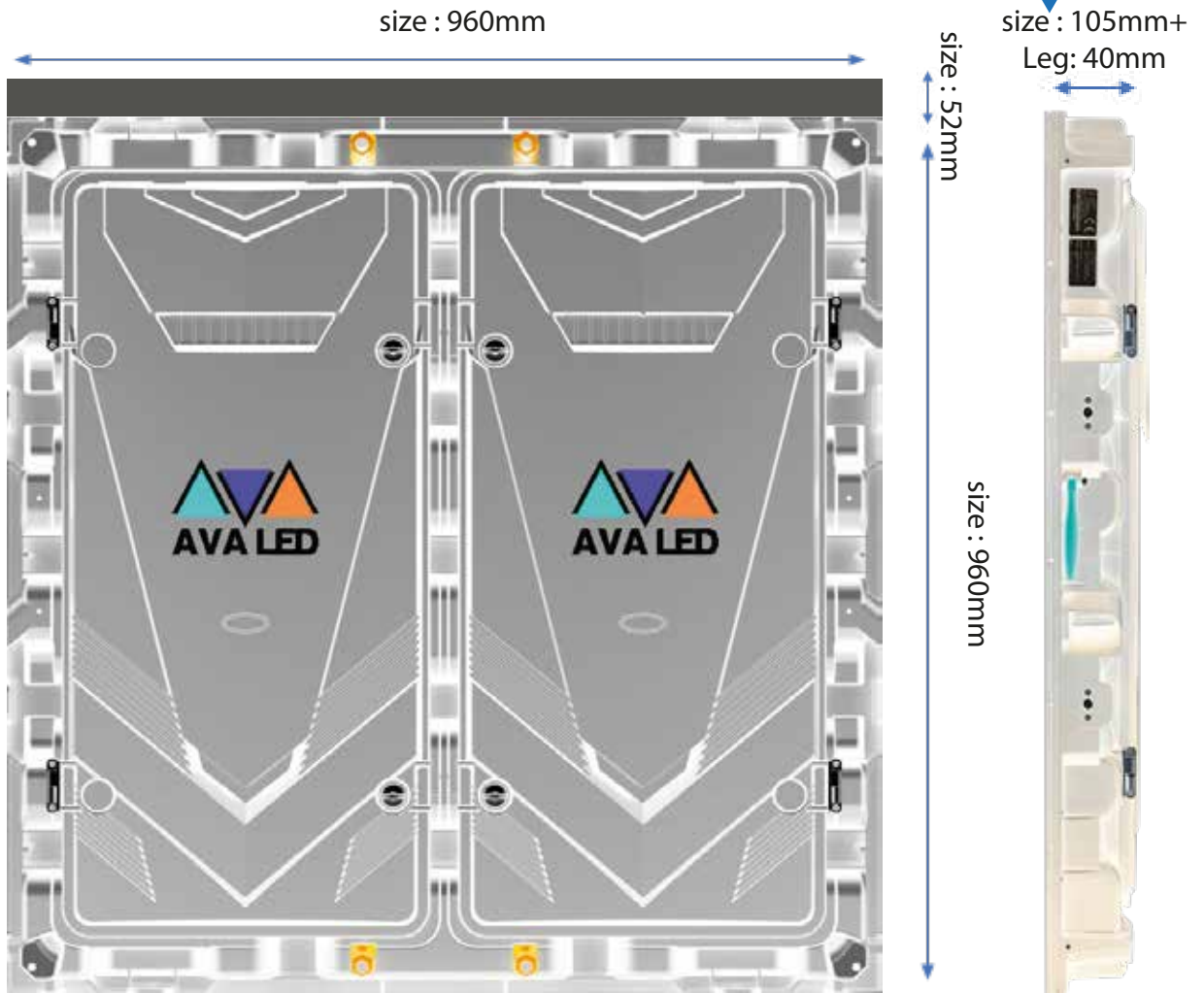

27KG.



4 IN 1 - 147KG.

QUALITY IN DETAIL

PRODUCT PHOTO

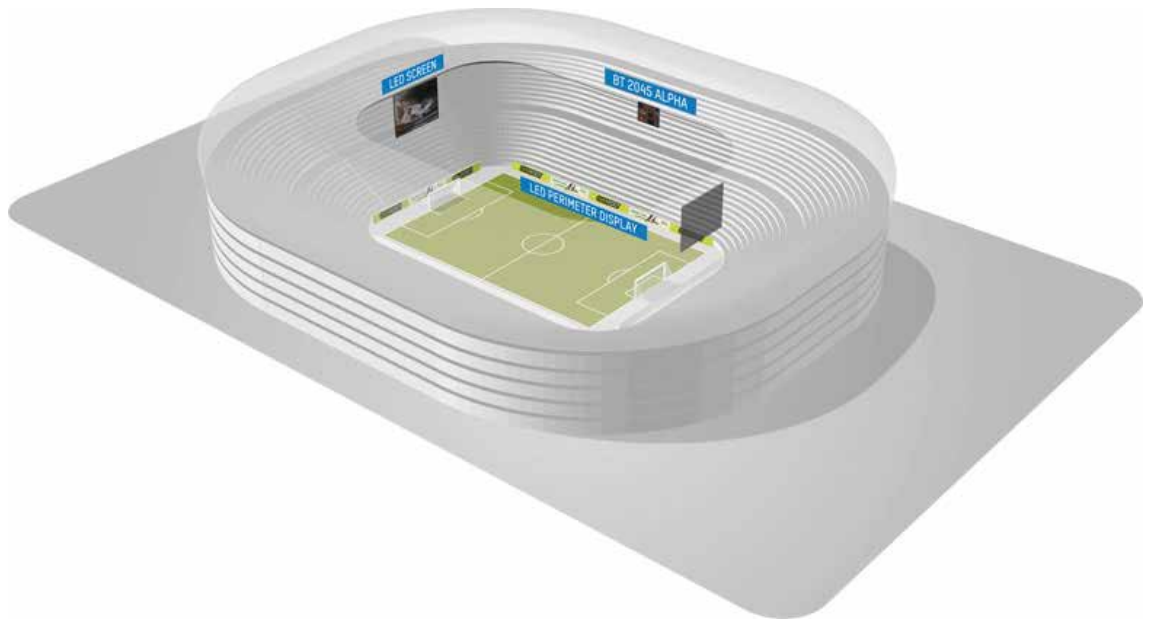

CABINET DETAIL

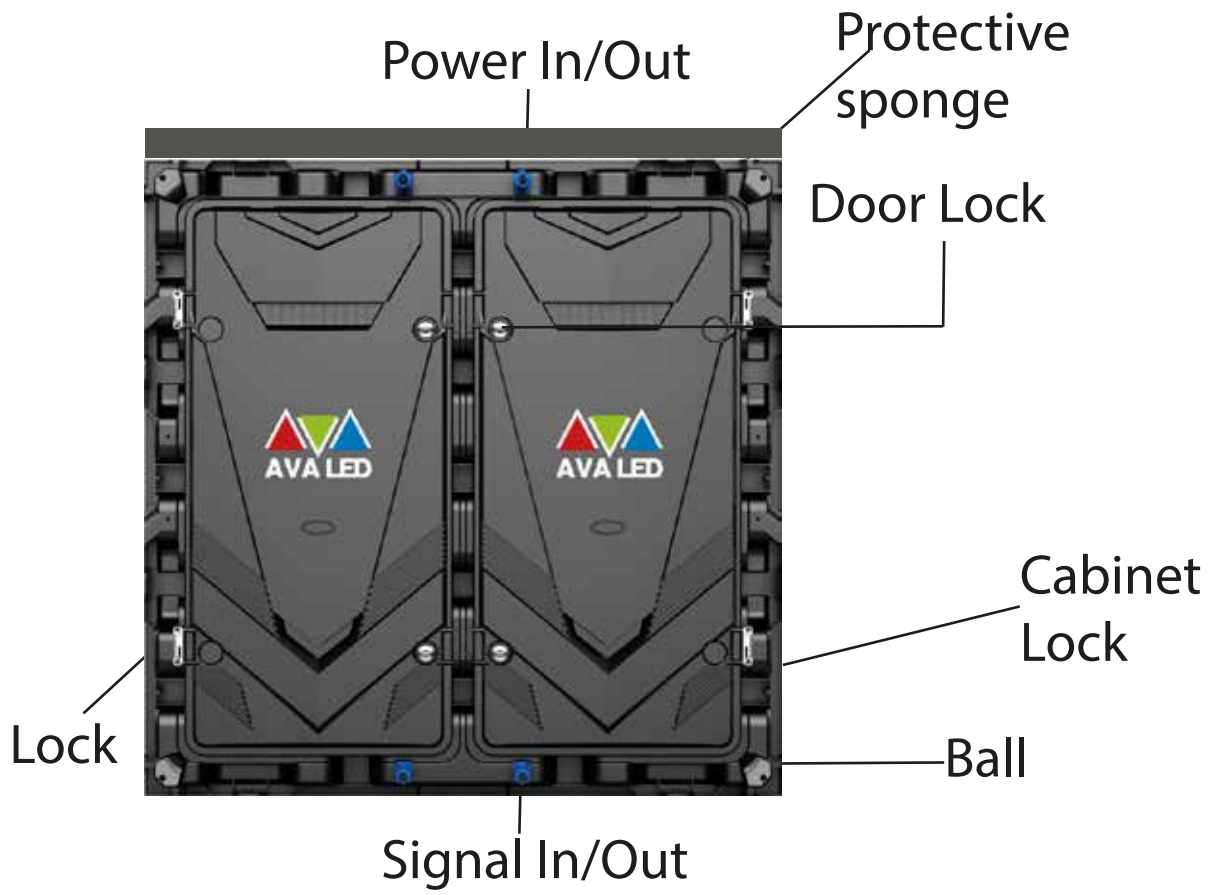



CASE



HANDLE



LOCK



BALL



POWER

SAFETY

The support structure has to be provided and installed by the customer because they vary from project to project. The following issues must be considered:

Environmental conditions: Humidity, wind, temperatures, rain, snow etc.

Ground stability

Front clearances: For making sure there is sufficient free area in front of the LED display screen and respect the maximum viewing angles and distance. Local regulations regarding such installation.

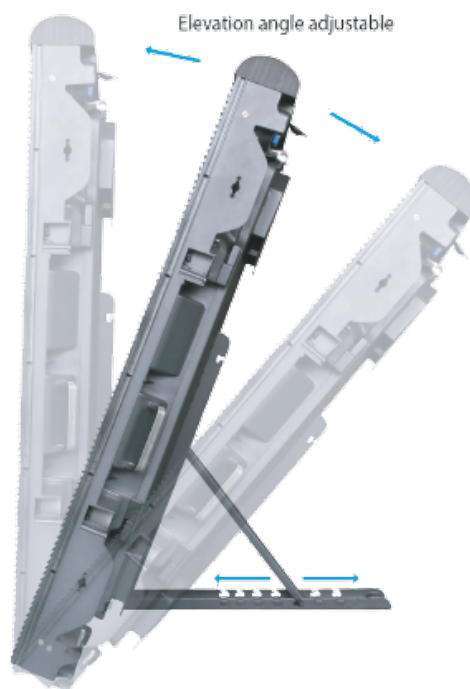

INSTALLATION

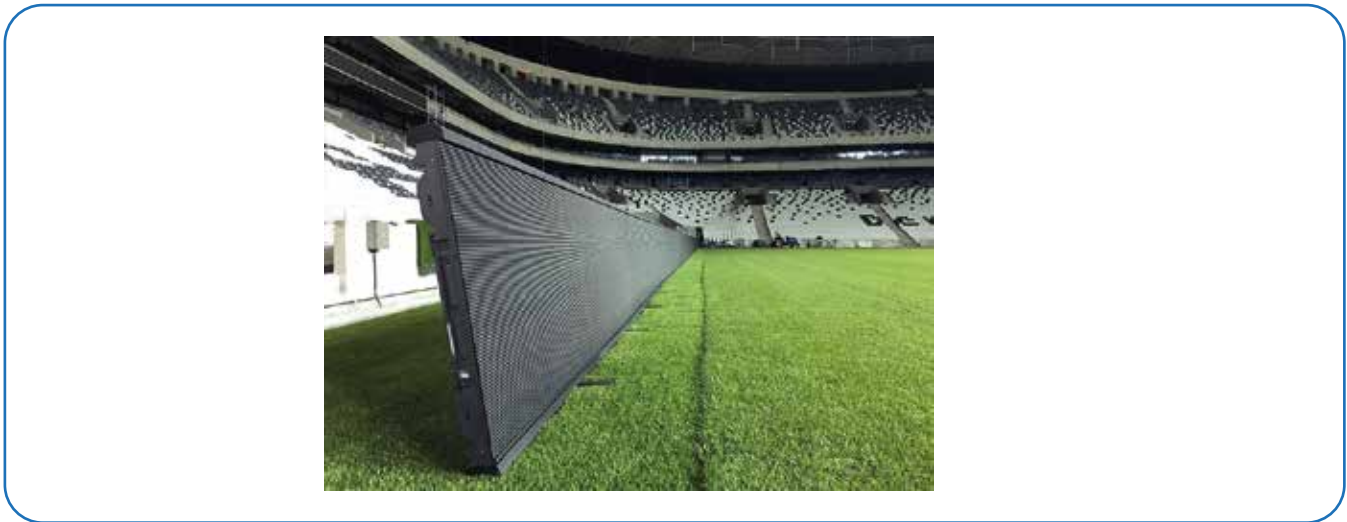
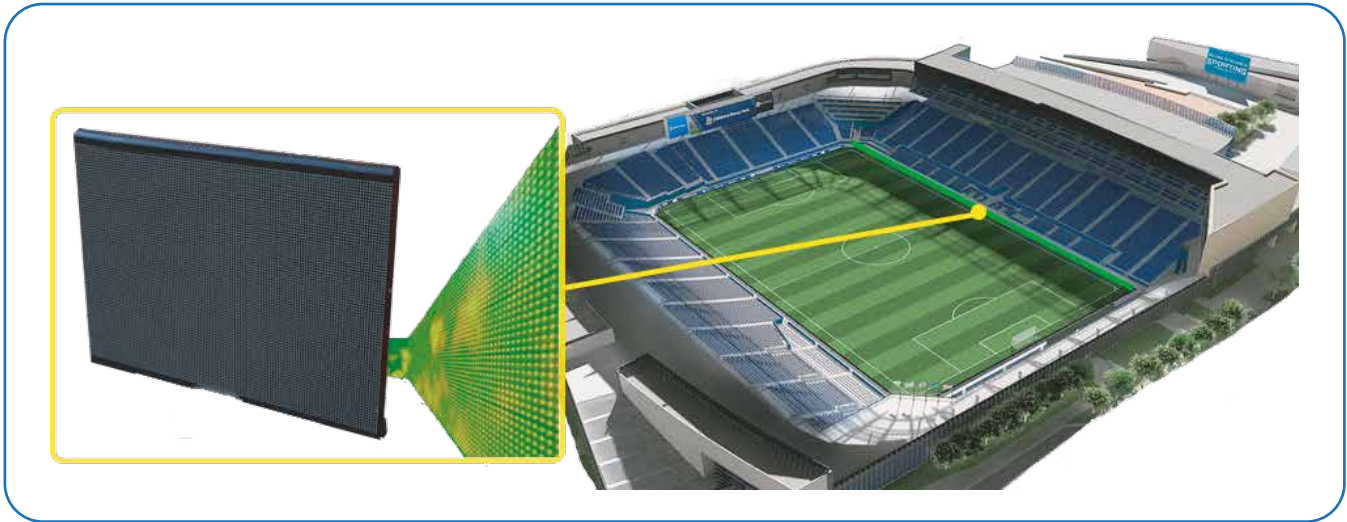
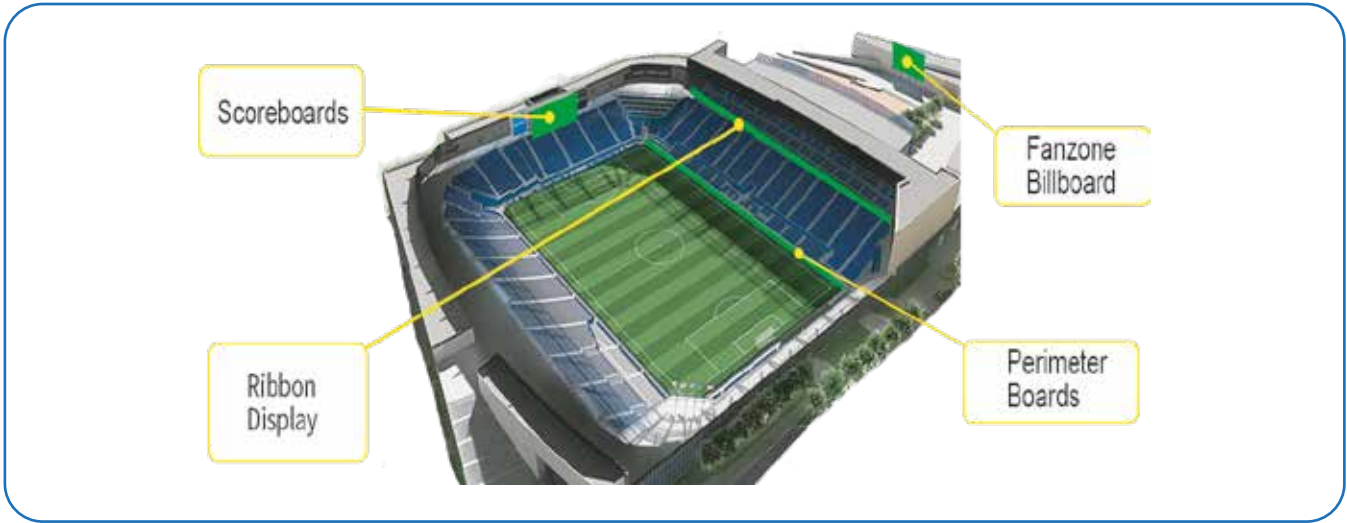

LEG



CASE



POWER



SIGNAL





AVA LED

www.avaledscreen.com

info@avaledscreen.com

AVA GROUP GMBH

Adress: Goethestraße 7D - 40237 Düsseldorf / Germany

Phone : +49 211 730 64 817

